

CAR-MON SERIES TSR-P TUBING STORAGE REEL

With Power Operator

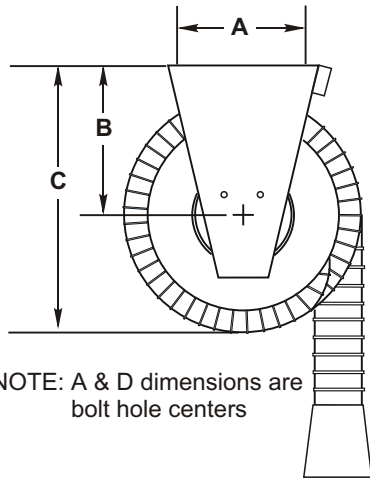

NOTE: A & D dimensions are bolt hole centers

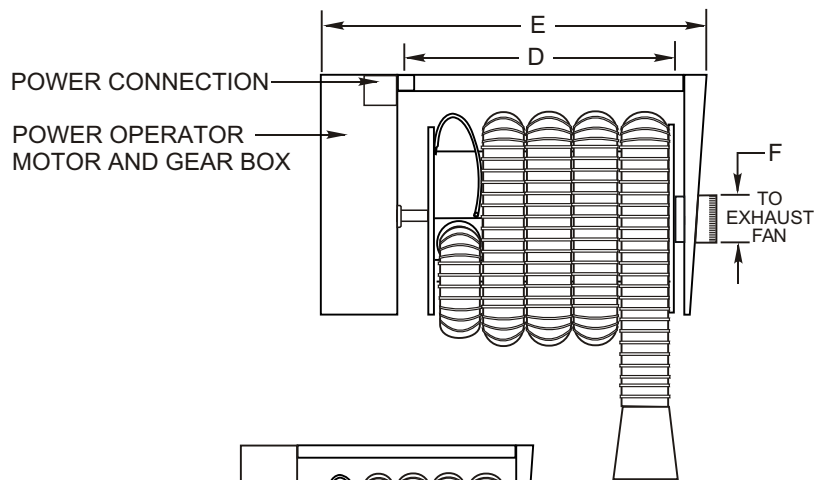

POWER CONNECTION
POWER OPERATOR
MOTOR AND GEAR BOX

F
TO EXHAUST FAN

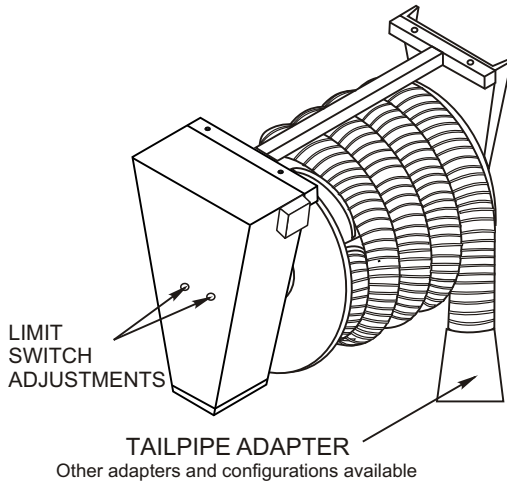

LIMIT SWITCH ADJUSTMENTS

TAILPIPE ADAPTER

Other adapters and configurations available

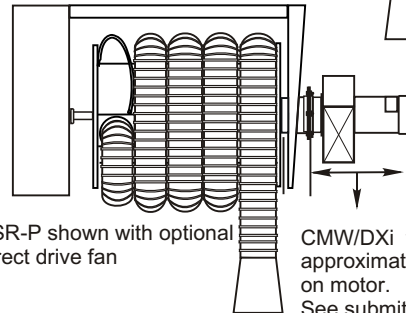

TSR-P shown with optional direct drive fan

CMW/DXi fan length is approximately 20 inches depending on motor. See submittal sheet for CMW fans and DXi fans for complete dimensional information.

OPTIONAL CONTROLS



Mounted Push Button (Standard)

WIRING BY OTHERS



Hanging Pendant Switch HPS



4 button pendant HP4

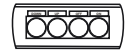

4 button station RB4

ELECTRICAL REQUIREMENTS

VOLTAGE	PHASE	HZ	HP
			1/3

QTY.	MODEL	HOSE DIA.	HOSE TYPE	HOSE LENGTH	ADAPTER	CMW/DXi FAN	OPTIONAL CONTROL	A	B	C	D	E	F	WT.
	TSR-P24	3"						9 3/4	18 7/8	31	26 3/4	42 3/4		150
	TSR-P24	4"						9 3/4	18 7/8	32	26 3/4	42 3/4		150
	TSR-P32	5"						9 3/4	18 7/8	33	34 3/4	50 3/4		160
	TSR-P32	6"						9 3/4	18 7/8	34	34 3/4	50 3/4		160
	TSR-P36	7"						9 3/4	19 7/8	35	38 3/4	54 3/4		170
	TSR-P36	8"						9 3/4	19 7/8	36	38 3/4	54 3/4		170

CAR-MON Series TSR-P is a tubing storage reel designed for use with Car-Mon Hose. Its frame is of welded construction using 2x2x1/8 square tubular steel with 12 gauge end plates, and an airtight rotating cylinder with a recessed inlet fitting to which the flange mounted flexible hose will be bolted. The motor operator for the reel consists of a 115/1/60 reversible gear motor standard and is controlled by an adjustable limit switch and reversing IEC contactor. The reel drive system comprises a direct drive coupling system. A remote mounted push button station for up down control is included. An optional hanging pendant switch as well as an attached direct drive fan, Series CMW or Series DXi are available as options. The standard TSR-P will accommodate up to 25' of hose. Other lengths and diameters, as well as explosion resistant, and special purpose reels are available, consult factory for details.

Note: Factory reserves the right to change dimensional data without notice.